

# KERAMA MARAZZI

Распашная дверь

VE.70.PD.CR

VE.70.PD.BLK.M

VE.80.PD.CR

VE.80.PD.BLK.M

VE.90.PD.CR

VE.90.PD.BLK.M

VE.100.PD.CR

VE.100.PD.BLK.M

Боковая панель

VE.80.FP.CR

VE.80.FP.BLK.M

VE.90.FP.CR

VE.90.FP.BLK.M

VE.100.FP.CR

VE.100.FP.BLK.M

Reversible/ Реверсивная



Внимание!

Инструкция по монтажу предназначена исключительно для квалифицированного работника.

Перед началом работ по установке, необходимо осмотреть все детали на отсутствие повреждений, которые могли быть вызваны транспортировкой, после установки претензии по внешнему виду, целостности и комплектности Товара не принимаются.

Во избежание возникновения дефектов при установке изделия необходимо внимательно изучить данную инструкцию и соблюдать все этапы сборки.

Компания несет ответственность только за производственные дефекты.

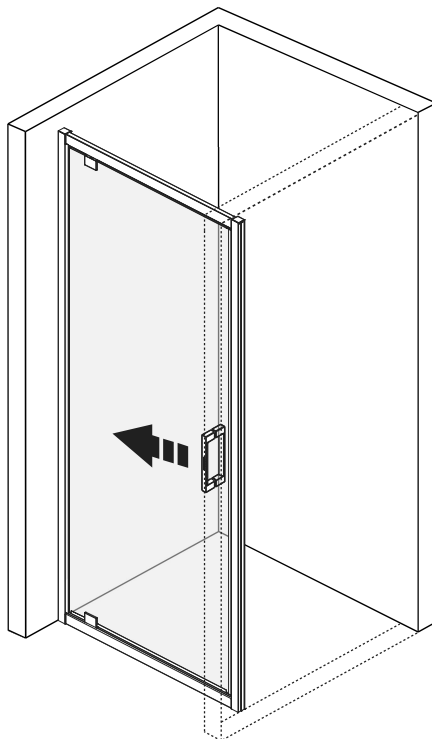
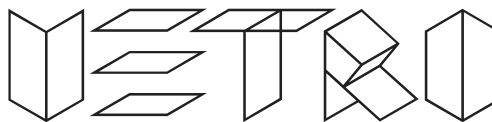

left/левое

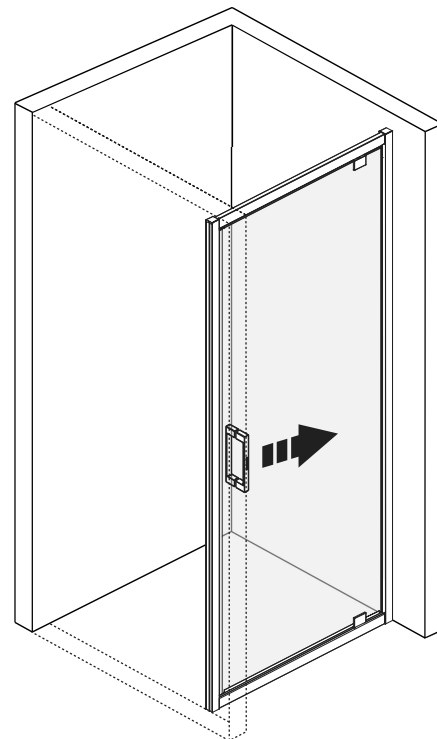

right/правое

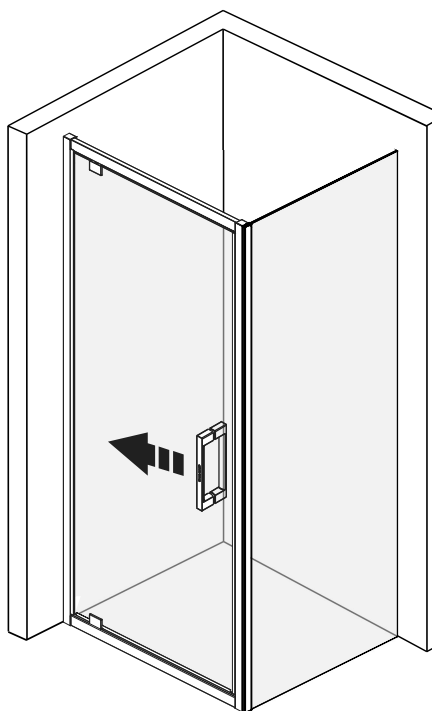

left/левое

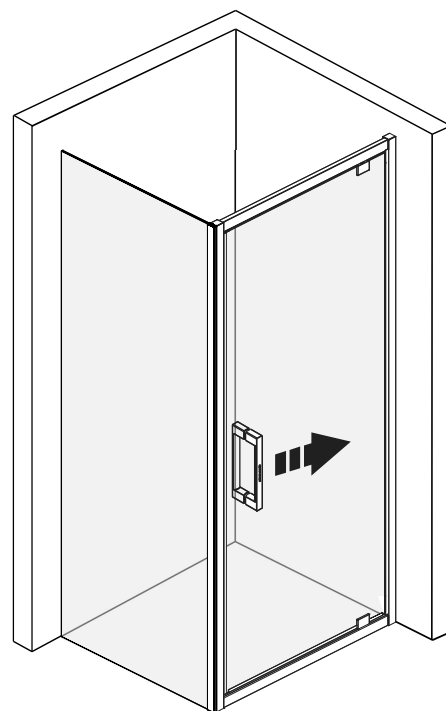

right/правое









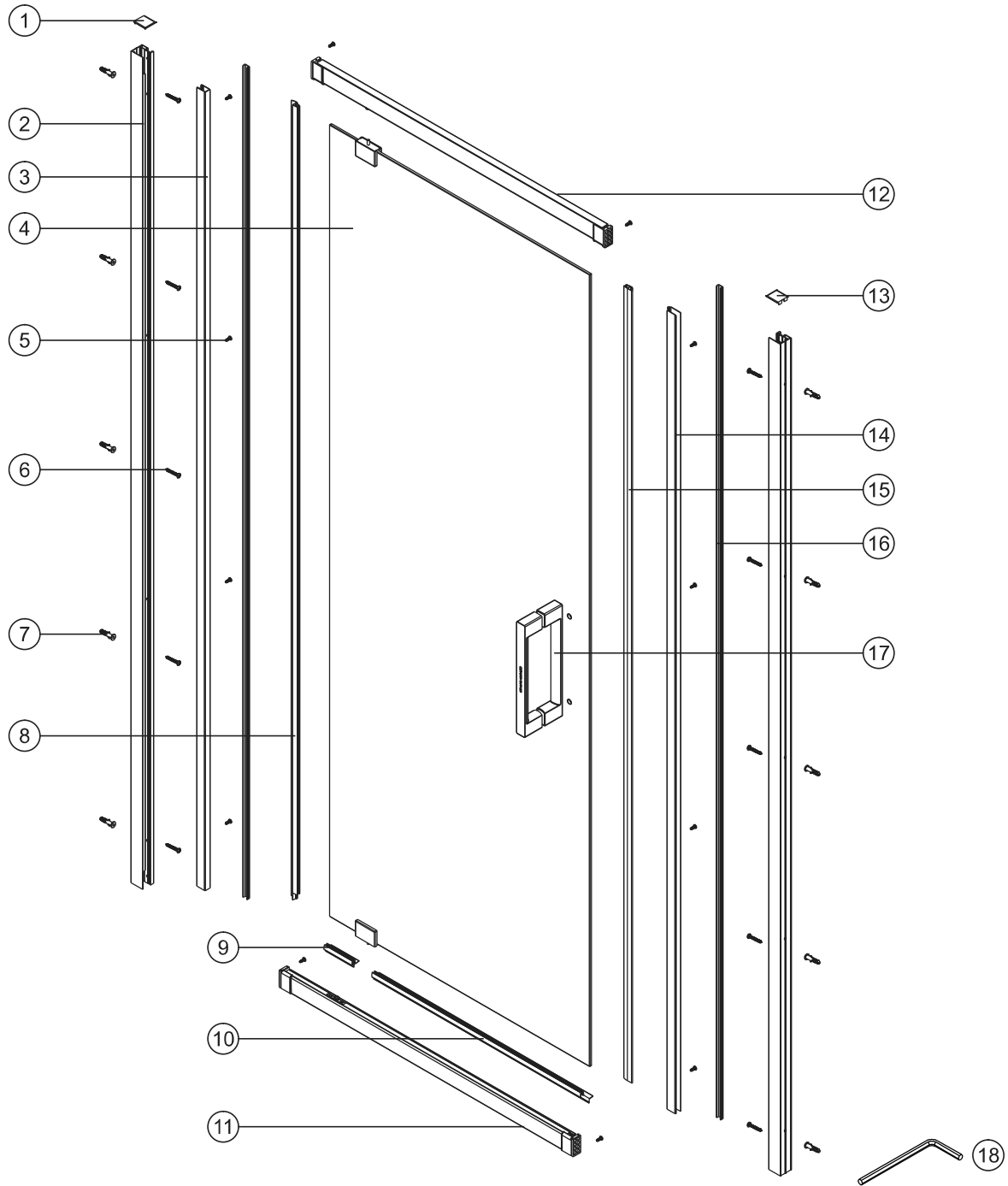

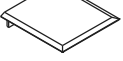

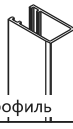
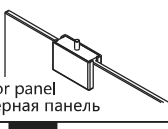

Левое или правое открывание  
Left opening or right opening

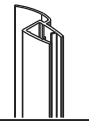
видеоинструкция по монтажу  
(video installation).

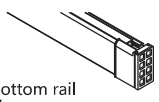
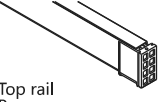



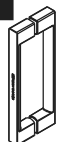



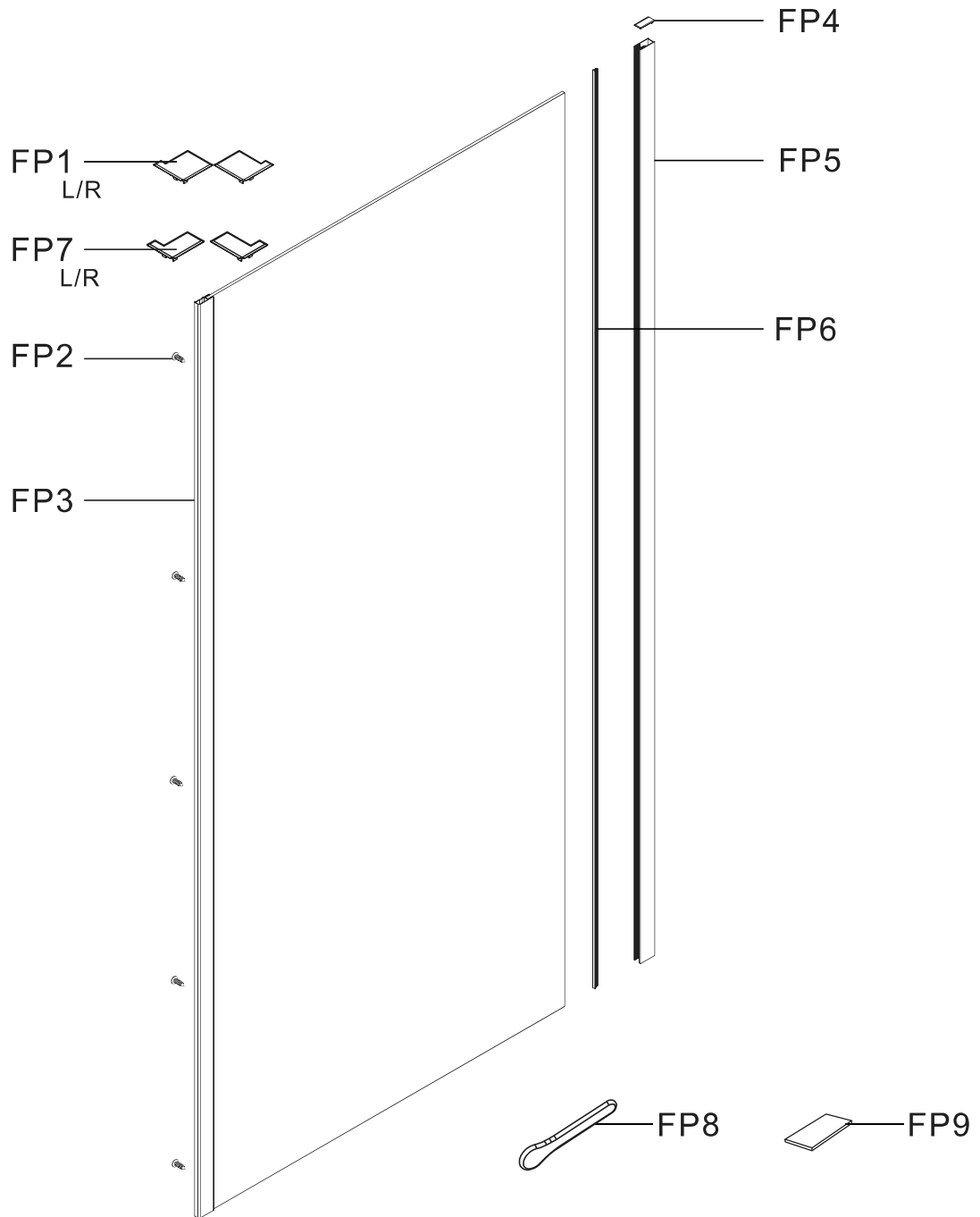

# Распашная дверь

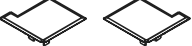

<b>1 x1</b>  Wall profile cap left Заглушка настенного профиля Левая	<b>2 x2</b>  Wall profile Настенный профиль	<b>3 x1</b>  Vertical profile Вертикальный профиль	<b>4 x1</b>  Door panel Дверная панель	<b>5 x12</b>  Screws ST4x13 Винт ST4x13	<b>6 x10</b>  Screws ST4x40 Винт ST4x40
<b>7 x10</b>  Wall anchor Дюбель	<b>8 x1</b>  Vertical seal Вертикальный уплотнитель	<b>9 x1</b>  Bottom seal Нижний уплотнитель	<b>10 x1</b>  Bottom seal Нижний уплотнитель	<b>11 x1</b>  Bottom rail Нижняя направляющая	<b>12 x1</b>  Top rail Верхняя направляющая
<b>13 x1</b>  Wall profile cap right Заглушка настенного профиля Правая	<b>14 x1</b>  Magnetism profile Магнитный профиль	<b>15 x1</b>  Magnet seal Магнитный уплотнитель	<b>16 x2</b>  Seal cover Крышка уплотнителя	<b>17 x1</b>  Handle Ручка	<b>18 x1</b>  Wrench Шестигранный ключ

# Боковая панель

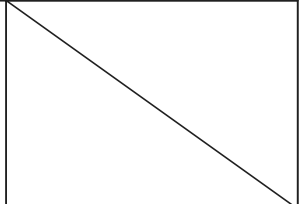

<p><b>FP1 x2</b></p>  <p>Corner profile cap (for pivot door) Заглушка углового профиля (для распашной двери)</p>	<p><b>FP2 x5</b></p>  <p>Screw ST4x10 Винт ST4x10</p>	<p><b>FP3 x1</b></p>  <p>Fixed panel Фиксированная панель</p>	<p><b>FP4 x1</b></p>  <p>Wall profile cap Заглушка настенного профиля</p>	<p><b>FP5 x1</b></p>  <p>Wall profile Настенный профиль</p>
<p><b>FP6 x1</b></p>  <p>Squeeze gasket Уплотнительная прокладка</p>	<p><b>FP7 x2</b></p>  <p>Corner profile cap (for sliding door) Заглушка углового профиля (для раздвижной двери)</p>	<p><b>FP8 x1</b></p>  <p>Installation tool Лопатка для монтажа</p>	<p><b>FP9 x2</b></p>  <p>Bottom seal Нижний уплотнитель</p>	

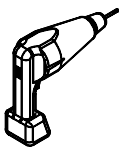
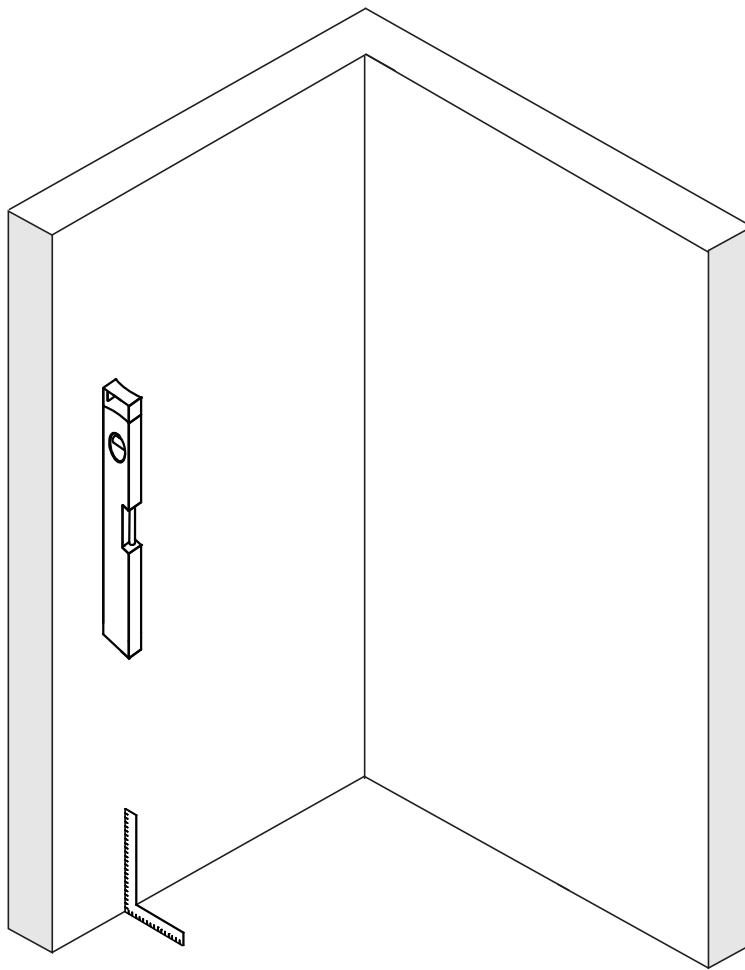

DRILL  
ДРЕЛЬ

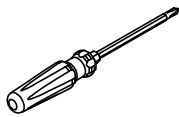

SCREWDR  
ОТВЕРТКА

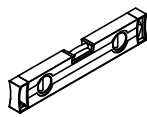

LEVEL  
УРОВЕНЬ



PRECISION KNIFE  
ТЕХНИЧЕСКИЙ НОЖ



SILICONE  
СИЛИКОН

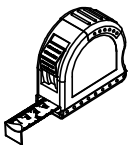

MEASURING TAPE  
РУЛЕТКА

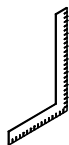

SET SQUARE  
УГОЛОК



PENCIL  
КАРАНДАШ



MALLET  
ДЕРЕВЯННЫЙ ИЛИ  
РЕЗИНОВЫЙ МОЛОТОК



Распашная дверь может быть установлена с правым или левым открыванием.  
В инструкции приведена установка с левым открыванием.

**A**

01

**Напольный монтаж**  
**Installation on a tile floor**

690mm - 710mm  
790mm - 810mm  
890mm - 910mm  
990mm - 1010mm

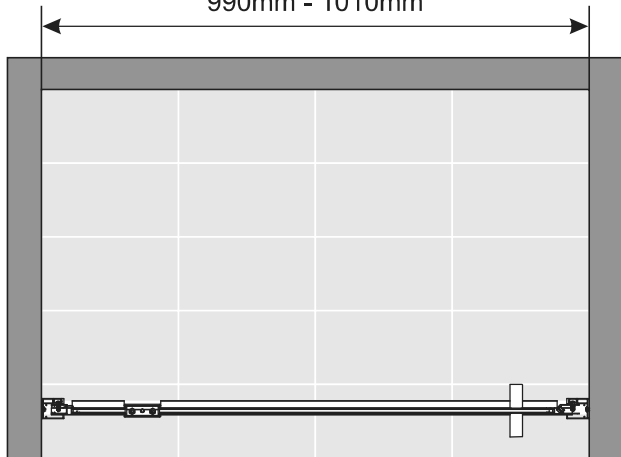

или  
or

**МОНТАЖ НА ПОДДОН**  
**on a shower tray**

690mm - 710mm  
790mm - 810mm  
890mm - 910mm  
990mm - 1010mm

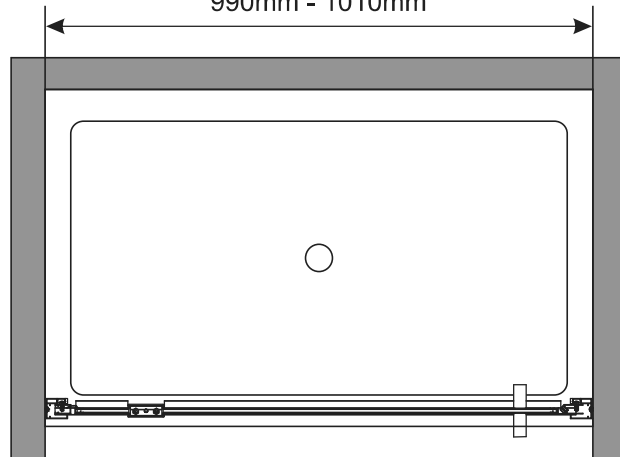

**A**

02

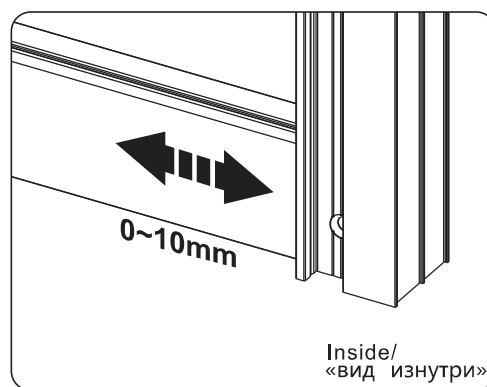
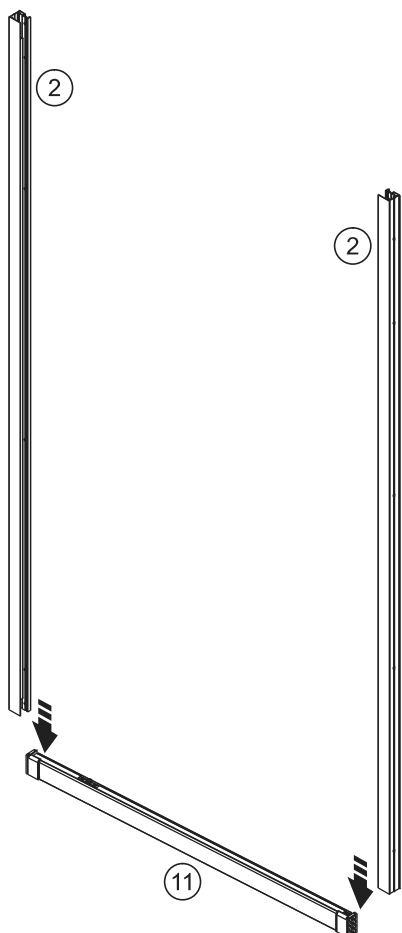

**A** 03

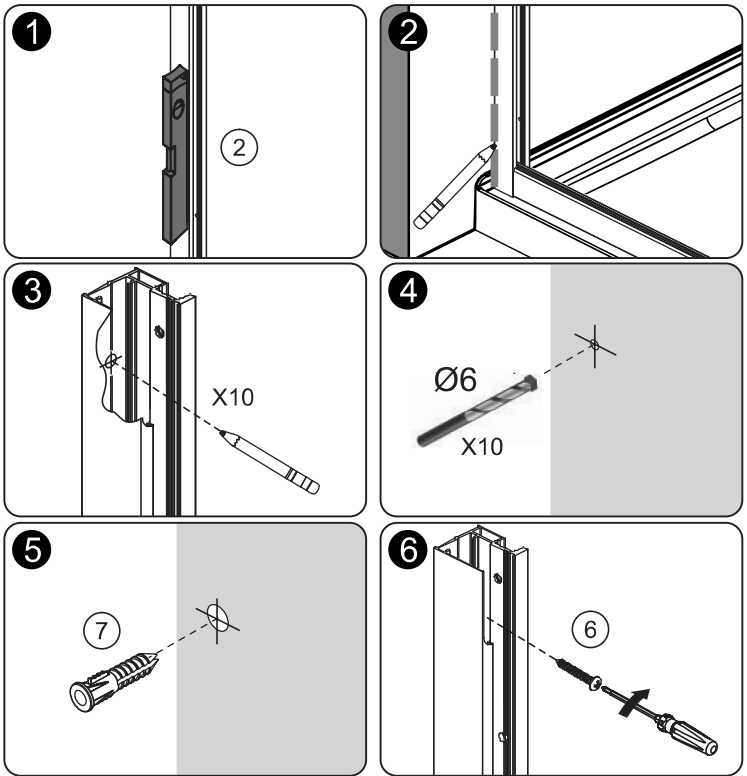
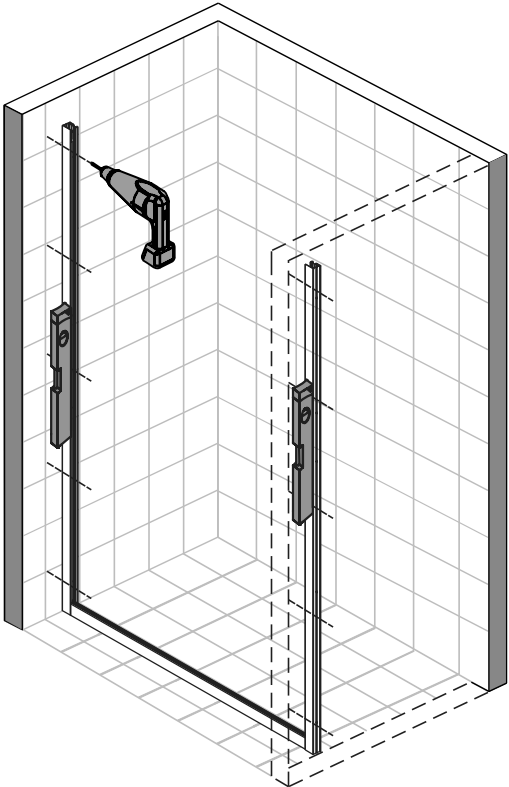

**A** 04

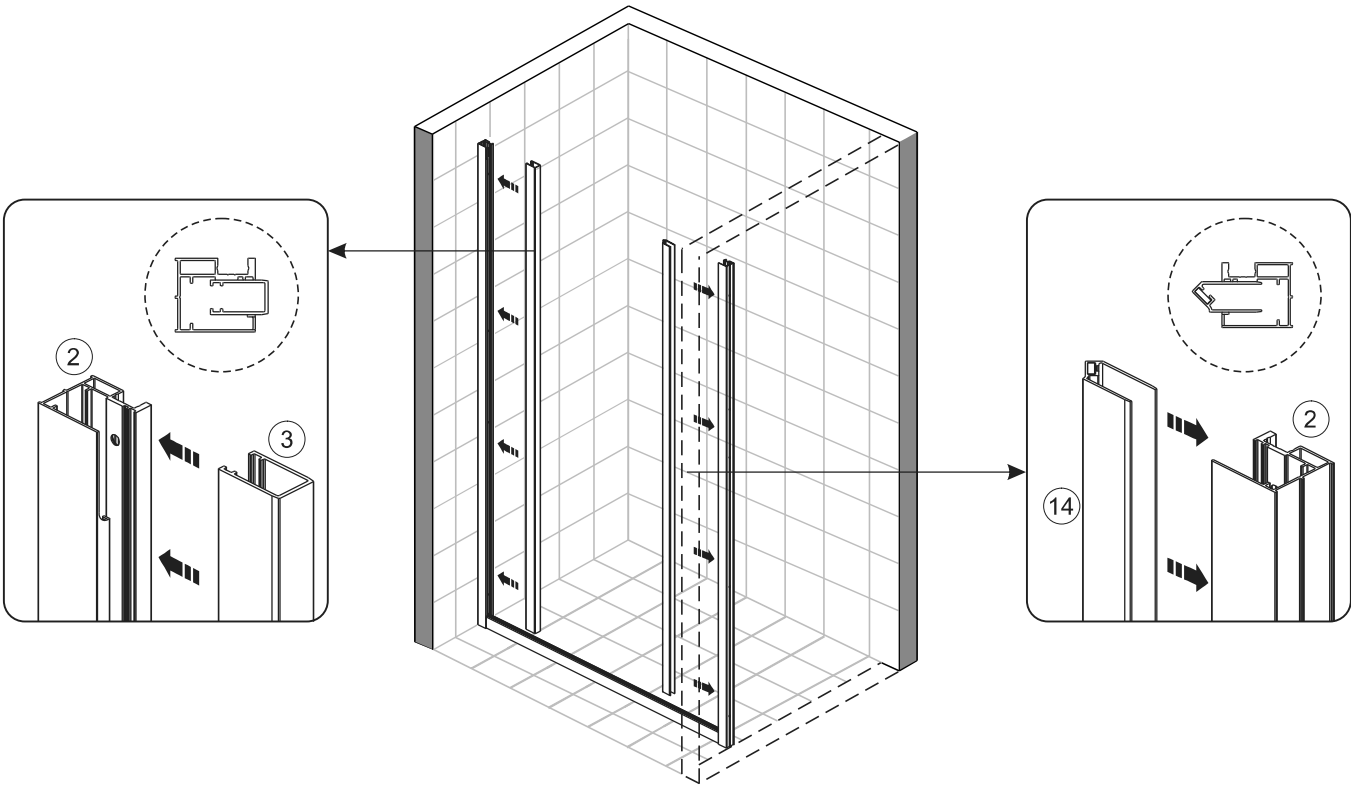

**A** 05

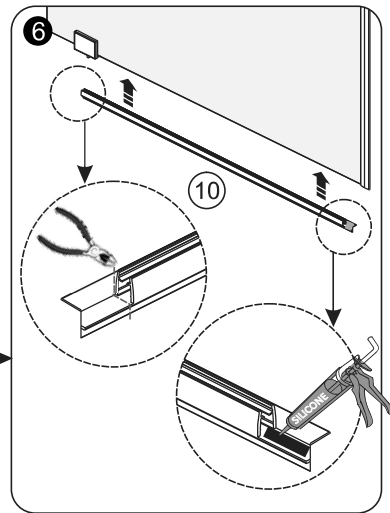
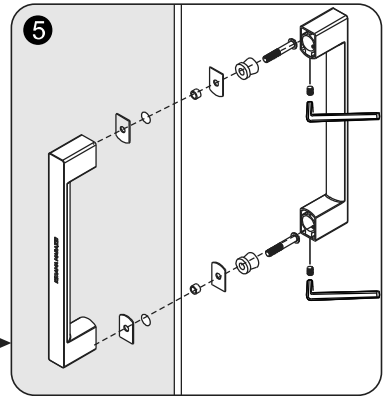
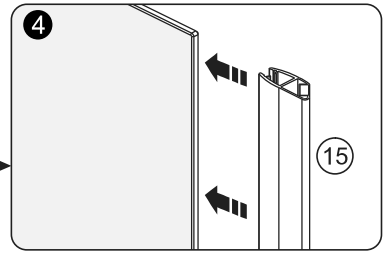
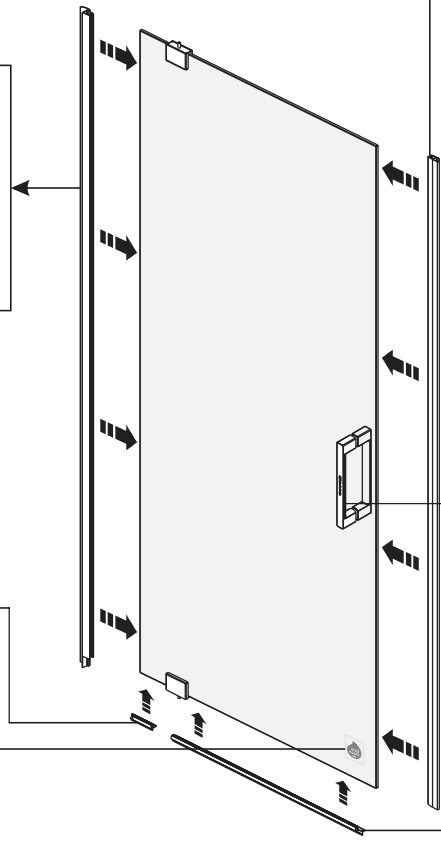
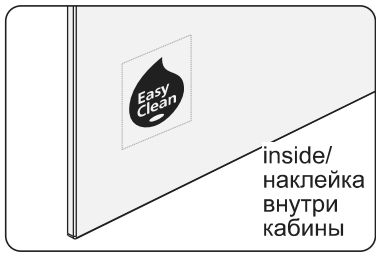
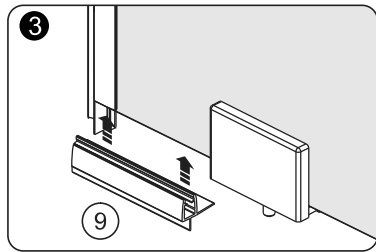
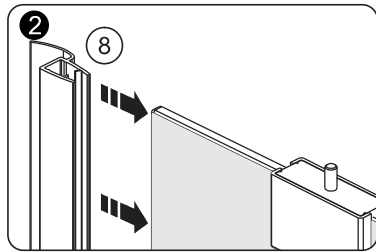
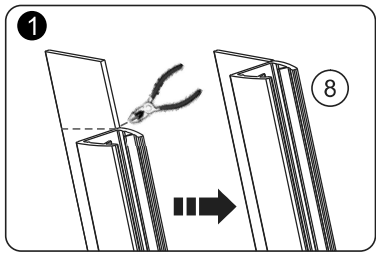

**A** 06

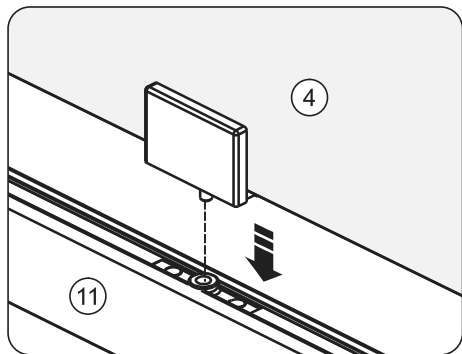
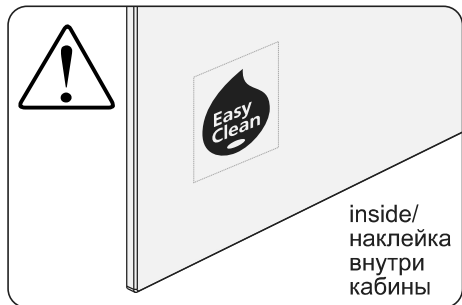
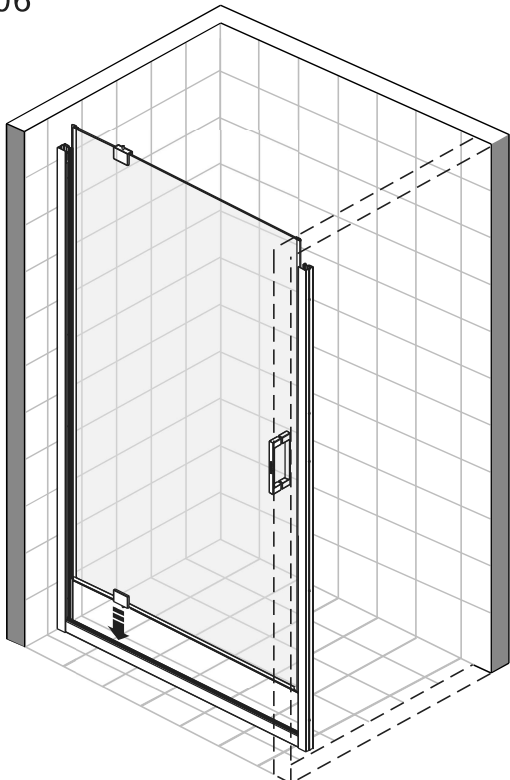

**A** 07

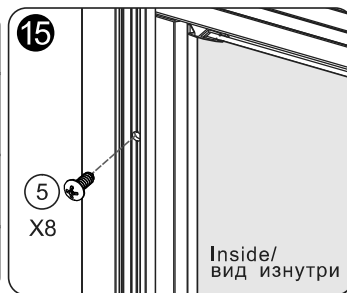
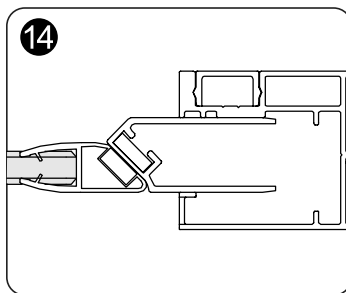
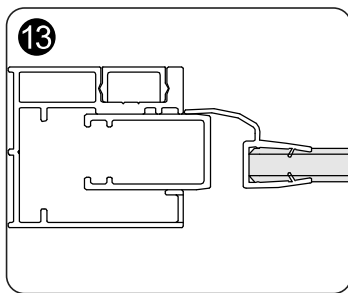
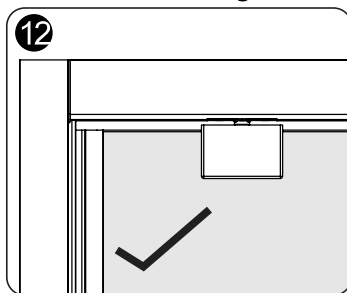
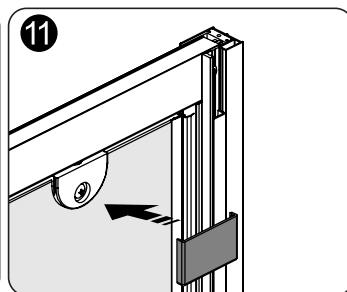
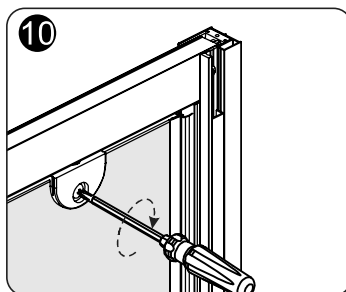
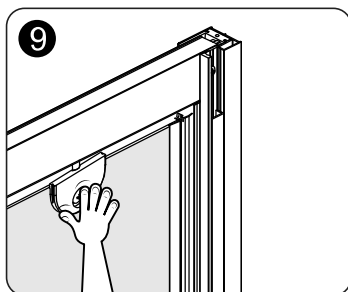
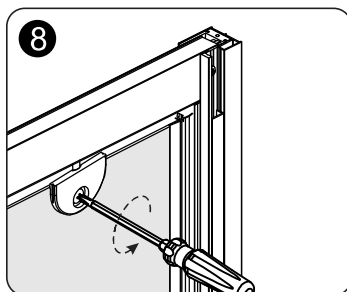
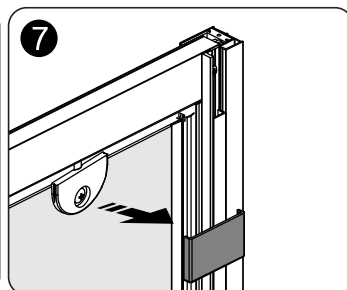
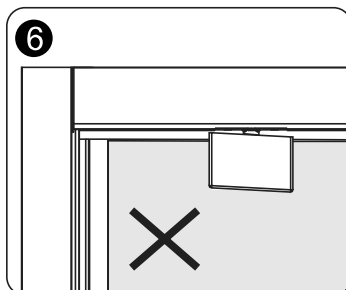
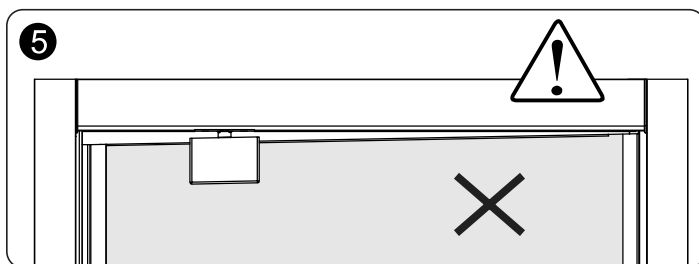
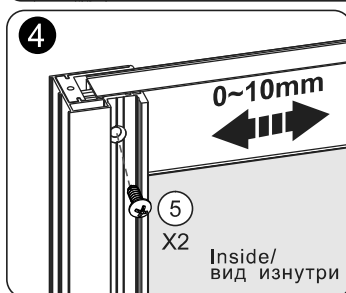
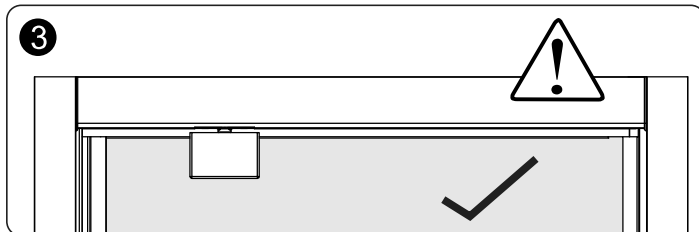
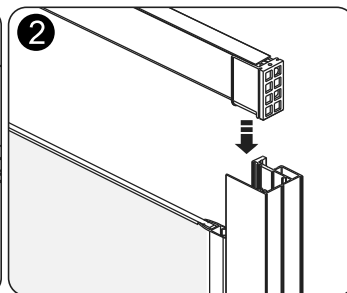
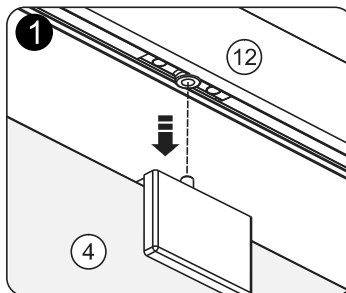
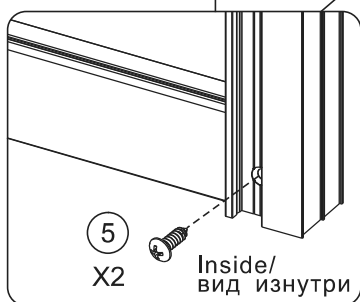
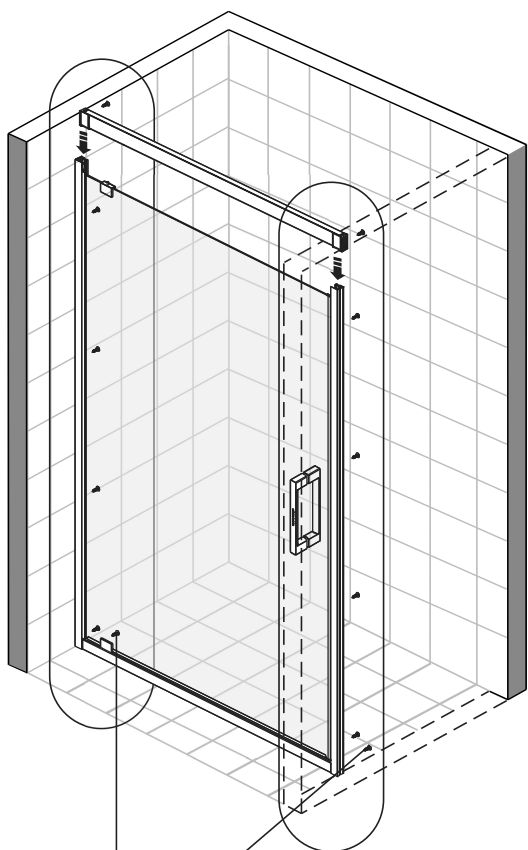



**A** 08

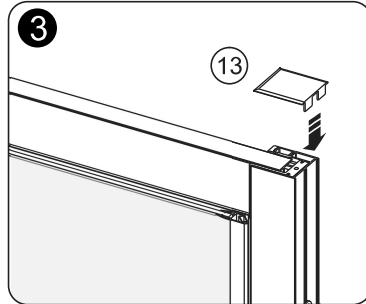
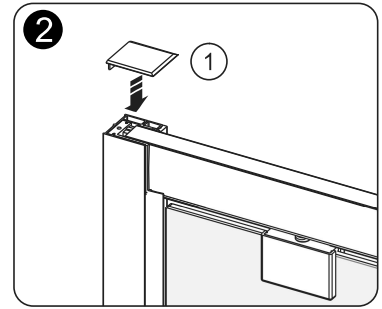
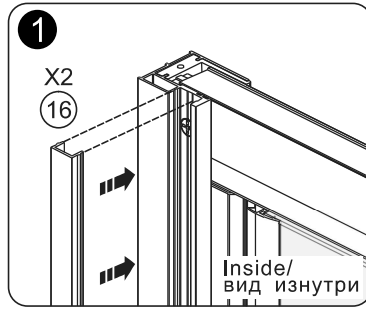
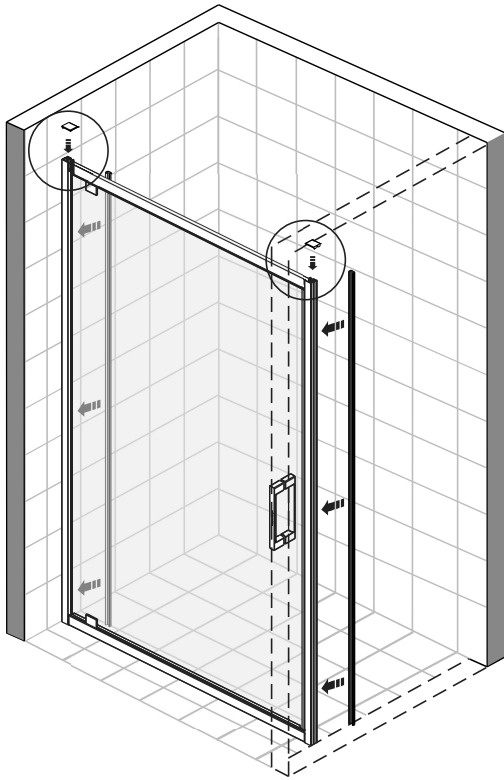

**A** 09

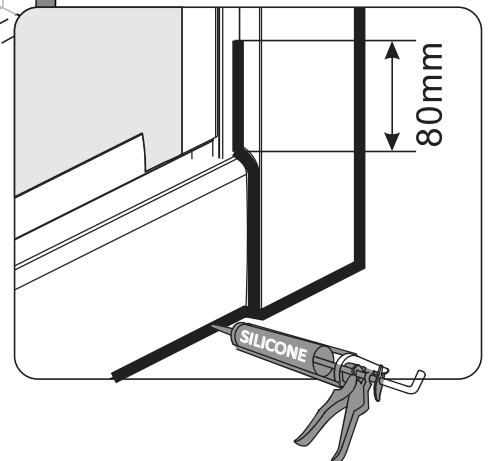
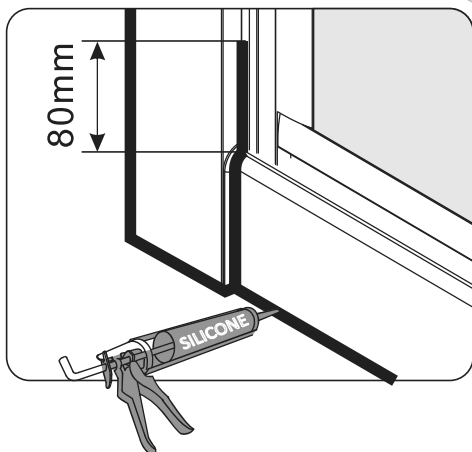
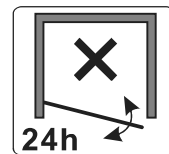
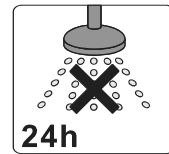
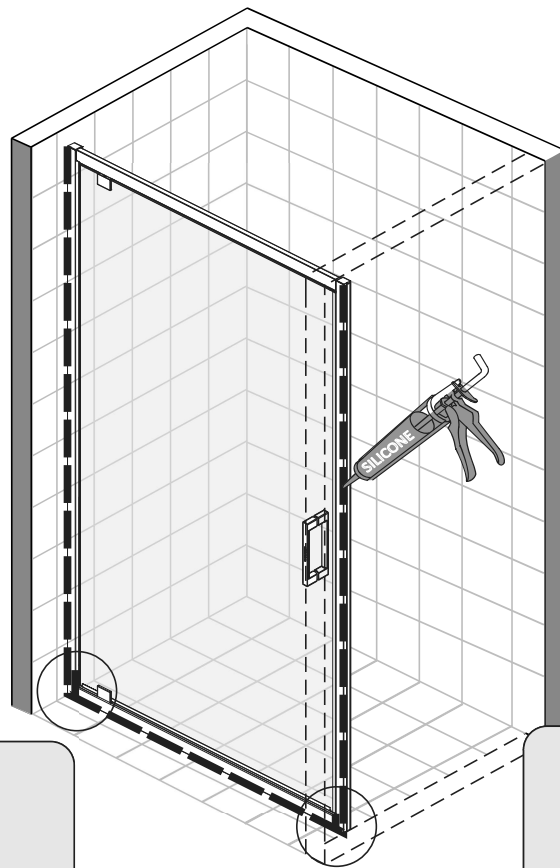

**B** 01

**Напольный монтаж**  
**Installation on a tile floor**

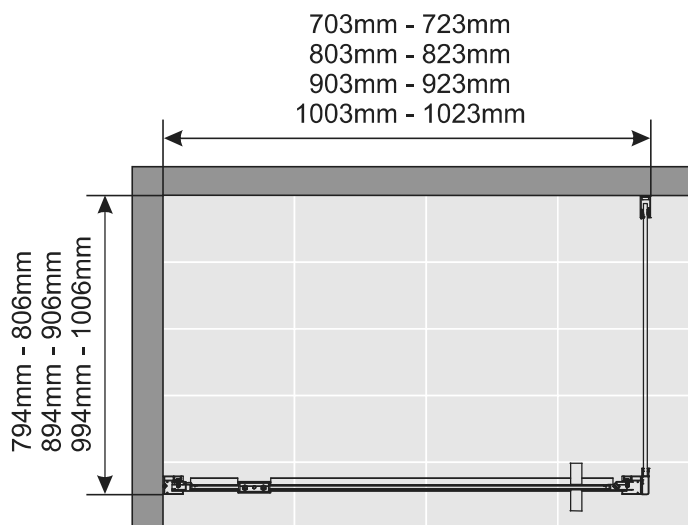

или  
or

**МОНТАЖ НА ПОДДОН**  
**on a shower tray**

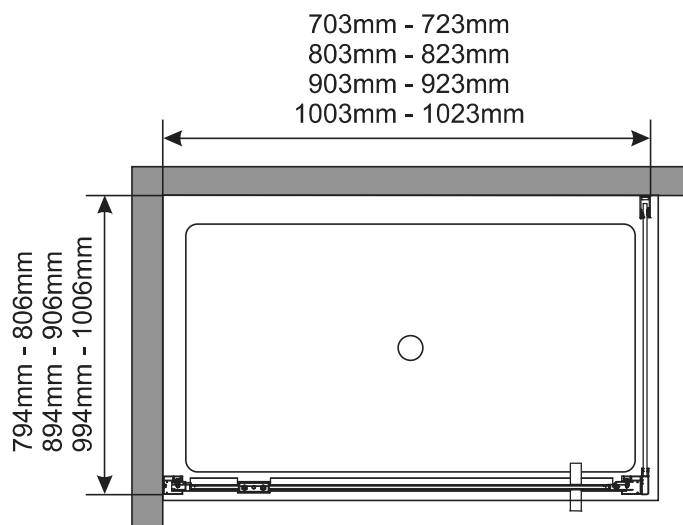

**B** 02

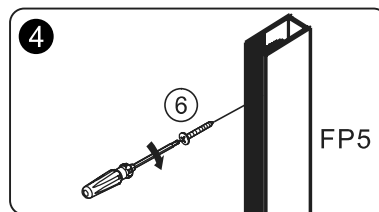
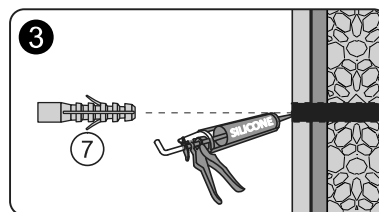
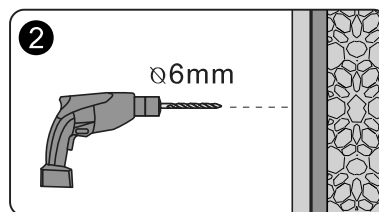
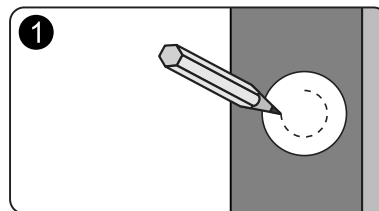
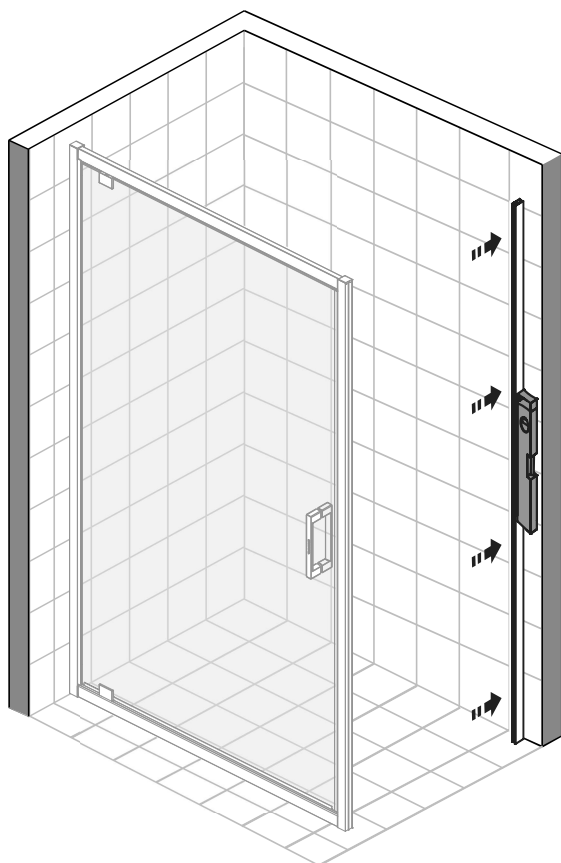

**B** 03

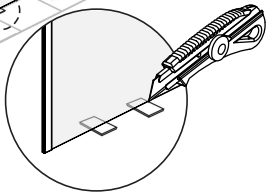
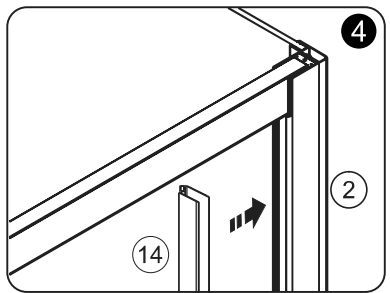
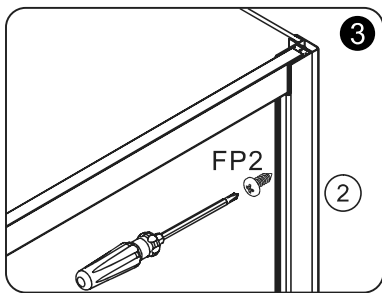
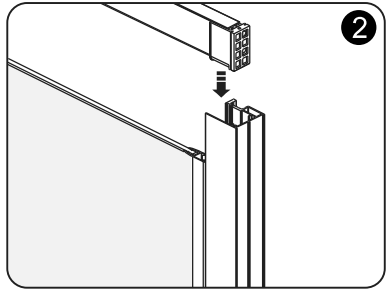
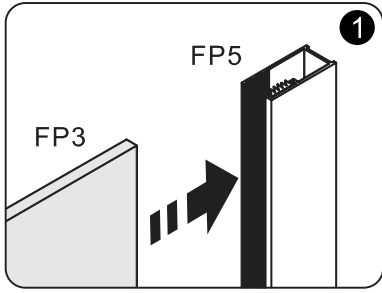
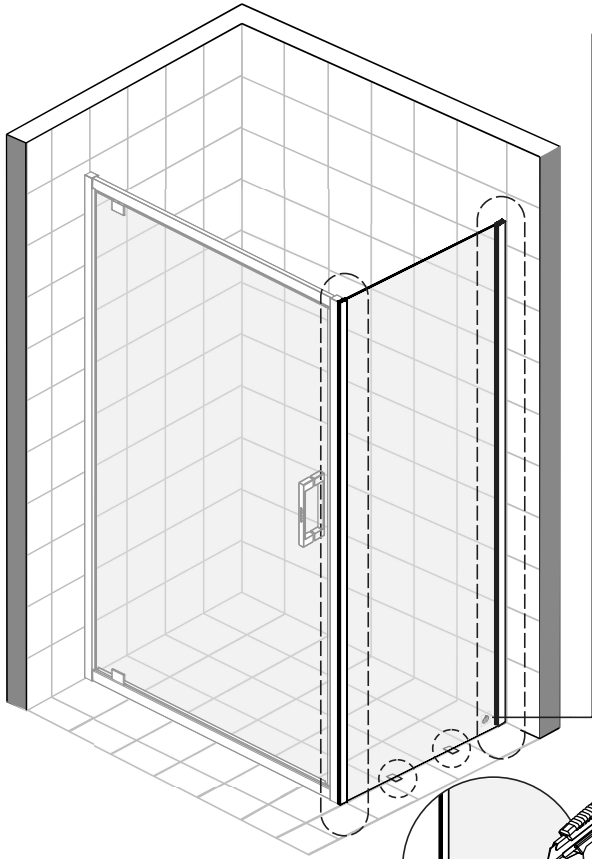

**B** 04

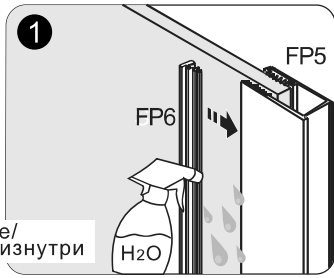
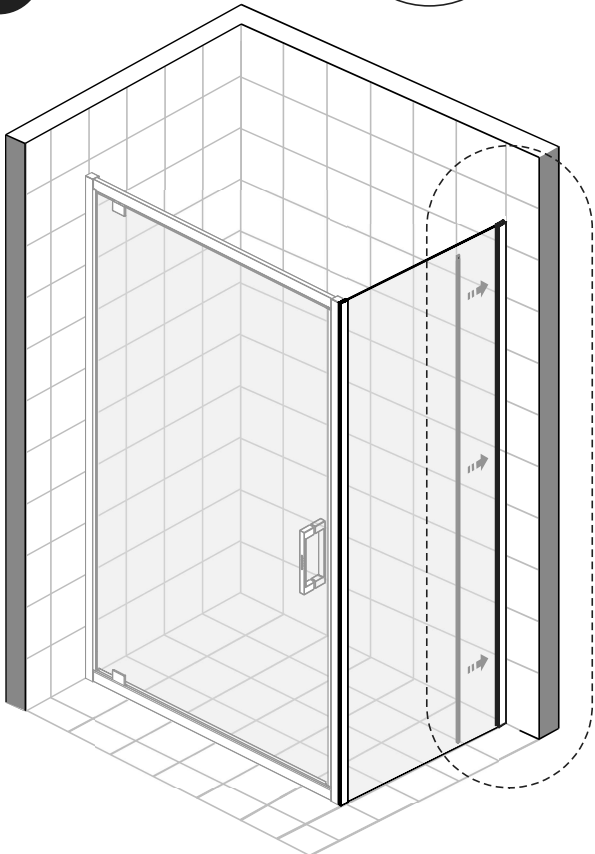

Inside/  
вид изнутри

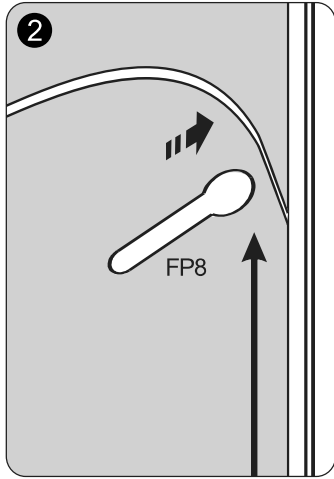

**B** 05

